

LUXI3EL



3 PATTEL 360TW

User Manual

Table of contents

Product introduction	3
Safety Notes	5
Maintenance	8
Installation	9
Control Menu	10
DMX Mode	11
Technical Specifications	12

Product introduction

Thank you for purchasing this Luxibel product.

For your own safety, please read the instruction manual carefully before turn on the product for the first time.

Before unpacking the fixture, please make sure that the packaging is in good condition and that following items will be found in the box:

- B PANEL360TW fixture
- 1.5m power cable with powercon

Description of the B PANEL360TW

- | | | | |
|---|-----------------------|----|-----------------------------|
| 1 | DMX-Input 5 pin | 8 | Enter- Button |
| 2 | DMX-Output 5 pin | 9 | Tft display |
| 3 | PowerTRUE 1 in | 10 | PowerTRUE 1 out |
| 4 | Manual dimming button | 11 | Mounting bracket |
| 5 | Menu Button | 12 | Locking screw for tilt lock |
| 6 | Up-Button | 13 | CCT Knob |
| 7 | Down- Button | 14 | Temperature Controlled Fans |

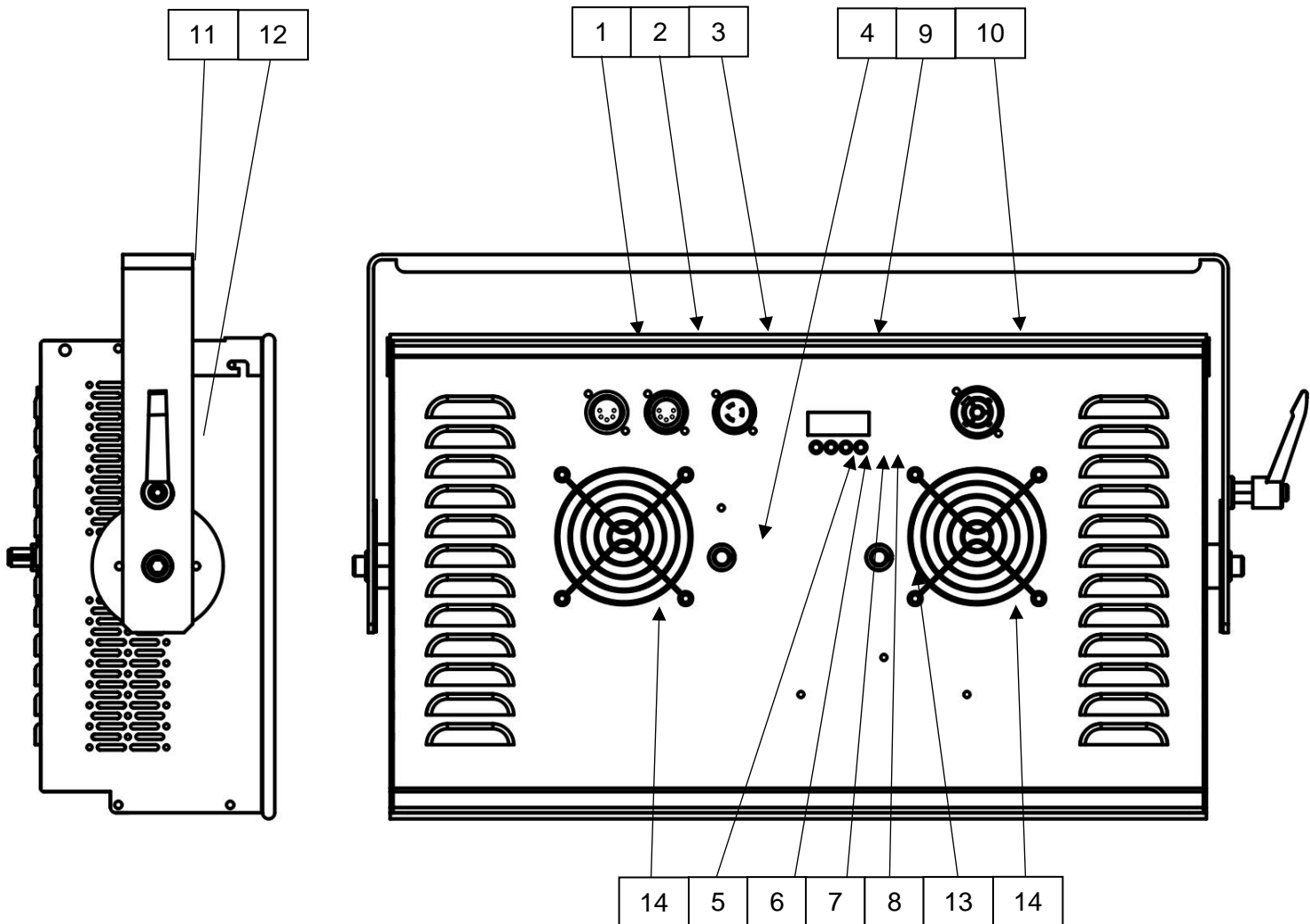

Safety Notes

Each person which is responsible for the installation, the usage of service of this unit must be qualified and has to follow the instruction in this manual.

This device is not meant for residential use.

Be careful when using the device. You risk an electrical shock from high voltage, if you touch the wires! The device has left our company in manufactured proofed state. To maintain this status and to ensure a permanent safe operation, it is absolutely necessary to follow the safety instructions and warnings in this manual.

Errors caused by not following these instructions are not covered by the warranty. The manufacturer will not accept liability for any resulting defects or problems.

- Keep the unit away from radiators or other heat sources!
- If the unit has been exposed to tremendous temperature changes (e.g. after transportation), do not turn the device on immediately. The resulting condensation could damage the unit. Don't switch the unit on until the device reaches room temperature.
- This device belongs to protection class I. This appliance must be grounded while in use to protect the operator from electrical shock.
- Make sure that the cable has never been squeezed or damaged by sharp objects. Check the device and the cables regularly.
- If the cable is damaged, it must be replaced immediately by the manufacturer, its service agent or a qualified person in order to avoid danger.
- Ensure that wires never come in contact with other wires! Handle the power cord and all connections with caution!
- Make sure that the line voltage is not higher than the voltage specified in this manual.
- Disconnect the unit from the AC mains when it is not in use or when cleaning it. Disconnect the connection only by pulling the cable plug.
- Maximum 12A interconnected
- Dry locations only.
- Do not under any circumstance connect anything other than or special updater to the USB-C port on the back of the fixture. Doing so will damage your connected device.

Risk of burns!

Do not touch the unit during operation! The housing may reach high temperatures!













Risk to health!

Never look directly into the light source. Especially epileptics risk an epileptic shock. Disconnect the unit from the AC mains when not in use or when cleaning it.

Defects caused by modifications of the device by unqualified handling or an unqualified person are not covered by the warranty.

Keep the product away from children and unskilled people.

There are no wear parts in the device. Maintenance and service must be performed only by an authorized service partner.

	Before operate this unit, please carefully read this users guide and keep if needed in future. It's necessary to respect following rules.
	The disposal of the device after lifecycle could damage the environment, need to take it to special company for recycling or return to authorized dealer.
	The products referred to in this manual conform to the European Community Directives and are therefore marked with CE logo.
	Keep this device away from children and unauthorized users, the manufacturer will not take responsibility for the damage due to any disregard of the information provided in this manual and wrong operation.
	Before operate the device, please make sure the fixture is in good housing, ensure pan and tilt can rotate in its complete range.
--0.5m	Please make sure minimal 0.5m distance need to kept between the fixture to any flammable material.
	The device can only run with 100-240V voltage, 50/60 Hz power, don't connect to any other wrong power. Disconnect the device from main power before open the shield or maintenance.
	The device is designed only for indoor usage, please keep it away from moisture. Do not expose the device under the sun or directly to any other lighting source.
	Never look directly into the projecting lens when the fixture is power on, the light may trigger epileptic seizures in photosensitive persons or persons with epilepsy. Especially at beam effect, extreme caution and observance of these safety instructions is mandatory.
	Don't put or install the device on a surface that subject to vibration or bumps.
Ta=45°C	The device is supposed to work in the temperate range -15° C and +45° C, do not use the device when the temperate exceed this range.
	Safety I class device, need to be earth connected.
	When the fixture is hanged overhead, the safety rope must be fixed to the bottom of the device to the appropriate fixing point.
	Always carry the device by the bracket, do not take the head directly for transportation.

Maintenance

Operation only allowed to qualified person, damages due to unprofessional operation or remove of any parts inside will not be considered in warranty service. There are no serviceable parts inside the device or package, service only leaves to authorized dealers.

Never allow the optical components contact with oil, fat or any other liquid.

A regular clearance of the device is needed for long-term usage, this is very helpful to maintain the lifetime and brightness need to use a soft and lint-free cloth to clean the optical system, fan and air flowing tunnel.

Trouble shooting

Problems	Possible reasons	Solutions
Device not power up	Powercon or power cable damaged Faulty power supply	Change a good power cable to try Replace new power supply
LED off	Temperature protection Fan not working Faulty LED Dimmer and strobe set at 0 Faulty power supply	Check the temperature from menu Check the fan speed info from menu Replace new LED Set dimmer channel at 255 and strobe channel at 0~5 Replace new power supply
Device not response to DMX	Faulty communication IC Faulty display PCB Wrong DMX addressing Faulty DMX cable	Replace the IC with back-up one in the display PCB Replace new display PCB Check the address and setting Change to a good DMX cable

Replacement of the fuse

Step 1: Unplug power cable from main power

Step 2: Unscrew the fuse holder out of the housing with a screwdriver

Step 3: Remove the broken fuse and replace with an exact same type of new fuse

Step 4: Insert the fuse holder back to the housing and screw tight and reconnect power

Installation

There are specific regulations like BGV C1 (old VBG 70) or country related regulations which need to attend during the installation. The installation has to be handled by skilled persons only!

Suspension device has to be built and calculated in order to handle up to 10 times its specific load limit over a time of one hour without permanent or harmful deformation.

Installation has to be done with a separate, independent suspension device like a safety chain. A second suspension device has to be built in order to assure that in case of error no part of an installation can fall off.

Trespassing the danger zone below the installation during the assembling is prohibited.

Installer has to take care of all safety and machinery installations are approved by authorized persons before first operation or after changes before restarting.

Installer has to take care of all safety and machinery installations are approved by skilled persons at least once a year.

Installer has to take care of all safety and machinery installations are approved by authorized persons every four years during the acceptance inspection. Spotlight should ideally installed outside peoples lounge area.

Attention

Installation overhead needs a high level of experience. This includes (but is not just limited to) calculation and definition of load capacity, used installation material and regular safety inspections of used material and the fixture itself. Never try to do the installation by yourself if you are not qualified, instead you have to instruct a skilled installer. Inappropriate installations can cause injuries and/or damage of property. Spotlight has to be installed outside areas where people can touch it.

Professional truss system or similar licensed suspension systems have to be used if the spotlight is used in suspension from ceiling or other constructions. Spotlights can never be installed freely suspended!

Spotlights can cause injuries when fall off. If you are not trained in questions of safety for the different kinds of installation do NOT install the spotlight! Assure that the mounting surface can hold at least ten times the point load of the spotlight before installing the fixture.

Assure the specified safety distances to flammable material.

Attach the spotlight with its yoke and the use of a suitable hook/clamp to your truss system. The therefor used opening has a diameter of about 12 mm. According to your installation also similar but approved suspension devices are possible.

When installing the spotlight overhead make sure to safe the fixture by a safety chain which is specified at least with a load limit of 12 times of the spotlights weight. Only safety chain with approved connective can be used. Attach the safety chain to its designated opening and attach it to the truss system or a similar and safe attachment point. Assure to close the fasteners as specified.

To adjust the angle of the fixture open the locking screw, set the fixture in its position and close it by hand.

Control Menu

1) Menu tree

Default settings shadowed.

MODEL NAME: B PANEL360TW	
DMX Addr	XXX
OL (Dimmer)	0-255
FLAS (Strobe)	0-255
LED (Flip display)	0-1
CH	2CH / 3CH / 6CH
Freq rate	1000Hz
	2500Hz
	2800Hz
	3300Hz
	4000Hz
	5000Hz
	6600Hz
	10000Hz
	20000Hz

2) Master/Slave Function

When fixtures are connected with the signal power, there is an automatic function of master/slave build in.

When no dmx is on the signal, the first fixture will act as master, all other fixtures connected in the signal line will follow as slave. When dmx signal is put on, it will disable the master/slave function automatically.

DMX Mode

DMX addressing

The device is controlled by universal DMX 512 protocol, DMX address is the start channel used to receive instructions from the external controller. For independent control, each fixture must be assigned its unique address control channels. For example, this device has Three channel modes: 2/3/6. if we set the mode at standard 2 channels mode, and there are several models need to be independently controlled, we just simply address first fixture at 1, and second fixture at 21, third one at 41, etc.

If the devices have the same address, they will behave synchronically.

DMX addressing is limited, don't set the address so high that without enough control channels for the fixtures.

Connection

Use DMX cable with 5-pin XLR-plugs to connect the controller with the fixture or one fixture with another.

5.1.2 This device is equipped with 5-pins DMX in and out sockets only.



Pin1 =GND Pin4 =N.A.
Pin2=SIG(-) Pin5 =N.A.
Pin3=SIG(+)

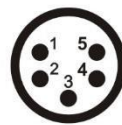

5.1.3 The termination is prepared by soldering a 120Ω resistor between pins 2 and 3.

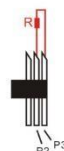
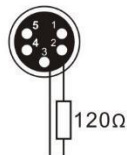

Technical Specifications

Dimensions drawing

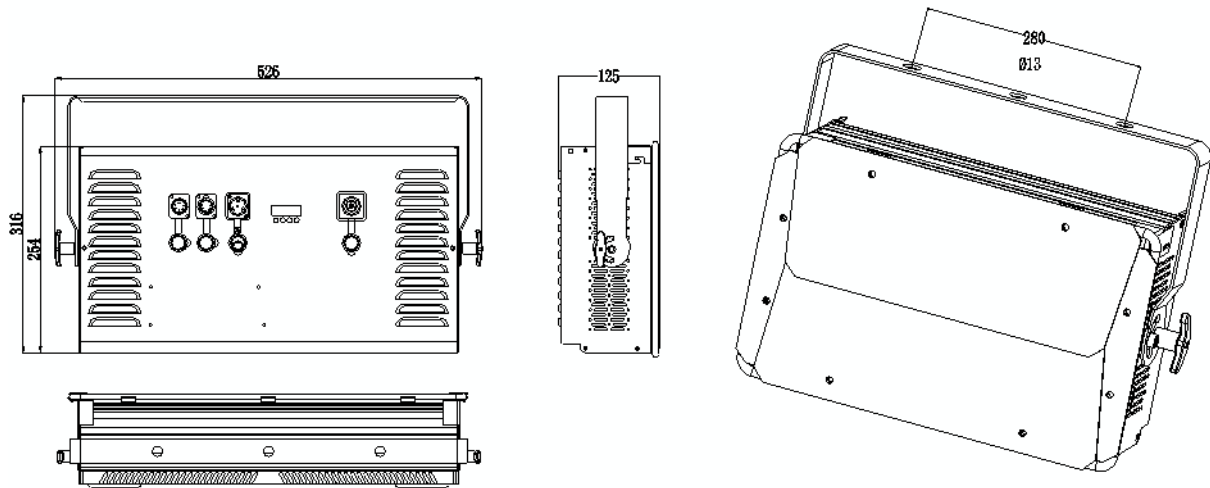

Physical

Dimensions (WxHxD): 526 x 320 x 150 mm | 21.7" x 12.6" x 5.9"

Packaging dimensions (WxHxD): 600 x 390 x 195 mm | 23.6" x 15.4" x 7.7"

Outer carton dimensions (2 pieces) (WxHxD): 620 x 420 x 420 mm | 24.4" x 16.5" x 16.5"

Net weight: 8.6 kg | 18.9 lbs

Gross weight (1 piece): 9.6 kg | 21.2 lbs

Gross weight (2 pieces): 19 kg | 41.9 lbs

Mounting options

Hanging: 3x M12 hole

2nd suspension / safety wire: 1x eye in back of unit to pass carabiner

Control

Menu control: TFT 4 digit display with 4 buttons

Control: DMX512, RDM, manual dimming & CCT button

In/Link: XLR 5-pin

DMX Mode: 2/3/6 channels

Dimmer mode 16-bit dimming

Movement: One hand tilt locking

Optical

Beam angle: 120°
Refresh rate: 1.200 – 9.000 Hz
Colours: 2.700k – 6.000K
CRI: 94.8 Ra
Strobe: 0-20 Hz

Photometric data B PANEL360TW (CW)

Lux @ 2m: 810 lux
Lux @ 4m: 260 lux
Lux @ 6m: 140 lux

Photometric data B PANEL360TW (WW)

Lux @ 2m: 870 lux
Lux @ 4m: 280 lux
Lux @ 6m: 135 lux

Electrical

Fixture rated power: 85W
LED engine: 360x White SMD LED
Input power: 100 - 240V ~ 50/60Hz Auto switching power supply
In/Link: PowerCon TRUE 1 - max. link current 12A

Environmental

Max. housing temperature: 50°
Cooling: Convectional + fans
IP rating: IP20

Accessories

1x Powercord TRUE1
1x barndoors
1x Gelframe*
1x Soft frost*
1x intensifier*

*Gelframe, Soft frost and intensifier are all mounted in front of the LEDs by unscrewing 2 fingerscrews



Contact

Luxibel

Bedrijvenpark De Veert 13/004

2830 Willebroek

Belgium +32 3

860 76 50

info@luxibel.com

www.luxibel.com